



# **Optical Fibre Communication & Mobile Communication Technologies**

for

**ATMIIS Batch XI**

**By-**

**Manish Rai**

**Scientist C**

**भारत मौसम विज्ञान विभाग  
INDIA METEOROLOGICAL DEPARTMENT**

# Optical Fibre Communication

❖ It uses light signals to carry information

## Transmitter

- It encodes message into a optical signal



## Channel

- Carries information to destination in the form of a optical signal



## Receiver

- Receives and Decodes the information from signal

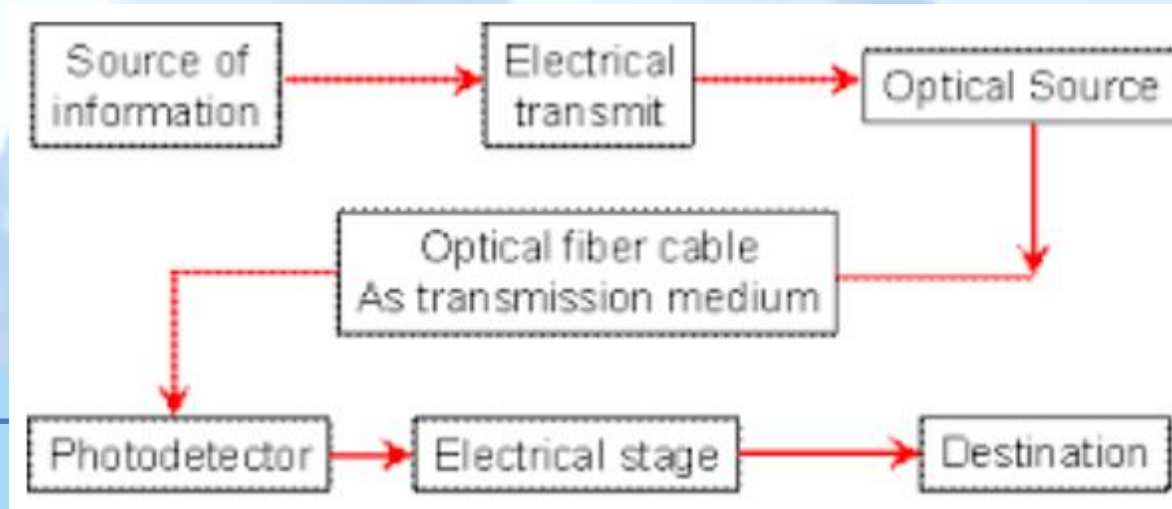

# OFC system Block Diagram

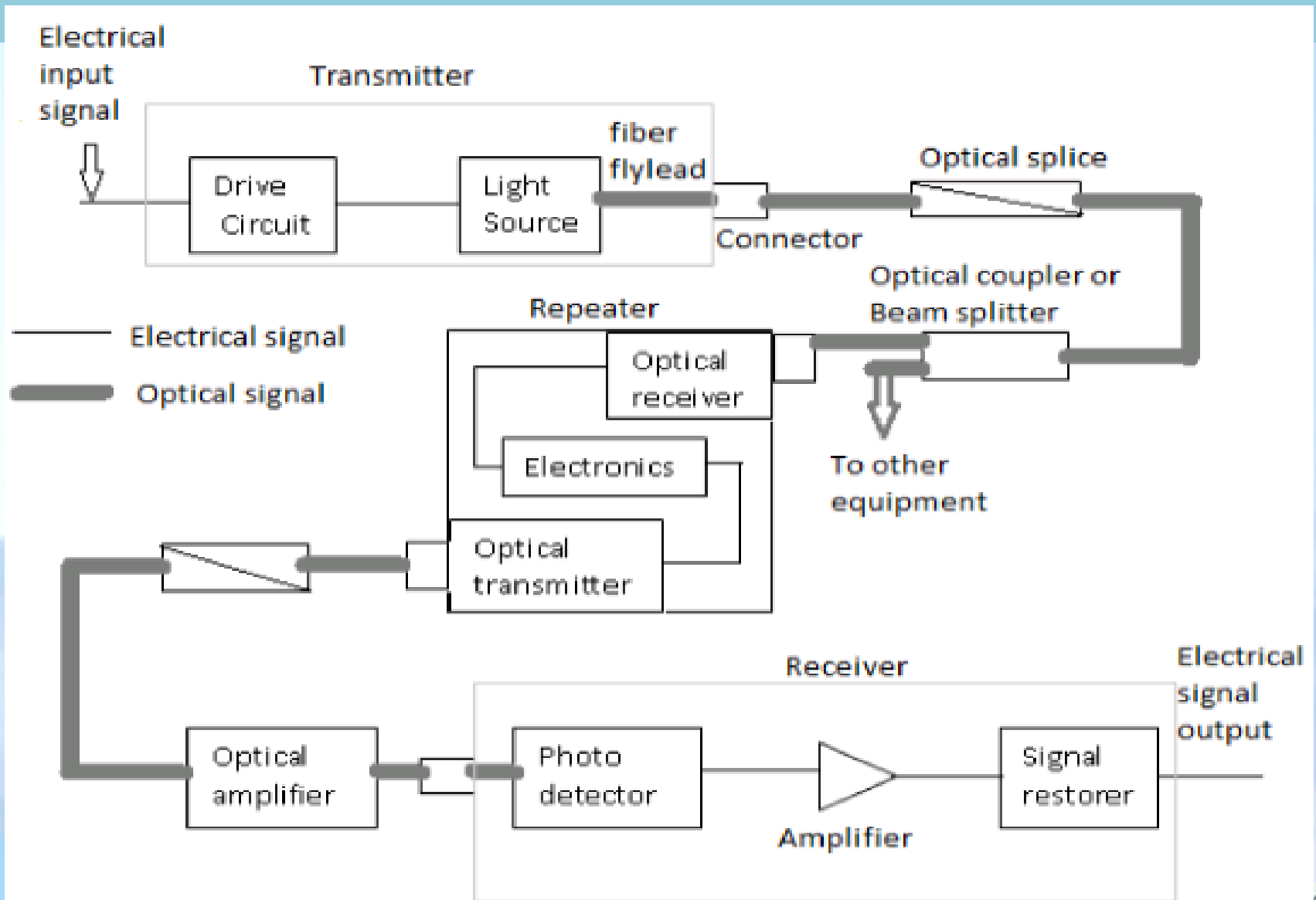

# Sources of Light in Transmitters

Drive Circuit or electrical stage drives an optical source to give modulated light wave carrier.

Optical source provides electrical to optical conversion. Requirements of optical sources are-

- High output power
- High linearity
- Narrow spectral width
- High modulation rate
- Temperature stability
- Long life time

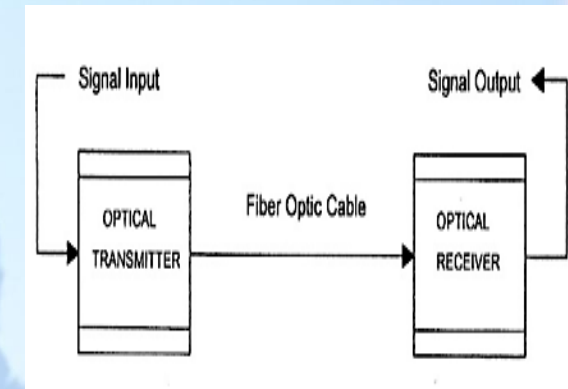
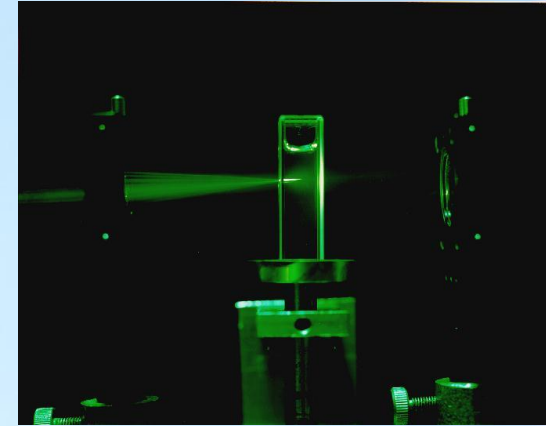

Generally used Optical sources-

- Light emitting diodes
- Lasers

- ❖ Mostly modulated at 850nm, 1300nm and 1550 nm
- ❖ Lasers give high intensity, high frequency light
- ❖ LEDs are economical



# Regenerator/ Repeater:

- After an optical signal is launched in to a fiber, it will become progressively attenuated and distorted with increasing distance because of scattering, absorption and dispersion mechanisms in the glass material.
- **Therefore repeaters are placed in between to reconstruct the original signal and again retransmit it.**
- The signal is processed in electronics domain and hence optical to electrical conversion and electrical to optical conversions are performed in the repeater.



# Optical Amplifier:

- After an optical signal has travelled a certain distance along a fiber, it becomes greatly weakened due to power loss along the fiber.
- Therefore, when setting up an optical link, engineers formulate a power loss budget and add amplifiers or repeaters when the path loss exceeds the available power margin.
- The periodically placed amplifiers merely give the optical signal a power boost, whereas a repeater attempts to restore the signal to its original shape.



# Receiver

**Optical signal is applied to the optical receiver. It consists of photo detector, amplifier and signal restorer.**

- **Photo detector converts the optical signal to electrical signal.**
- **Signal restorers and amplifiers are used to improve signal to noise ratio of the signal as there are chances of noise to be introduced in the signal due to the use of photo detectors.**



# What are Optical Fibres

- ❖ Thin strands of pure glass
- ❖ Carry data over long distances
- ❖ At very high speeds
- ❖ Fiber can be bent or twisted

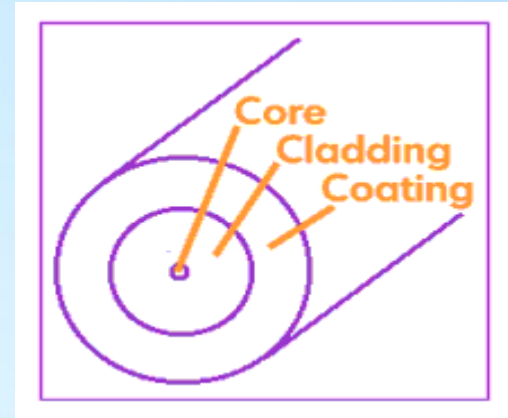



# Optical Fibres

- ❖ The most commonly used optical fiber is **single solid di-electric cylinder** of radius **a** and index of refraction  $n_1$ . The following figure explains the parts of an optical fiber. **This cylinder is known as the Core of the fiber.**

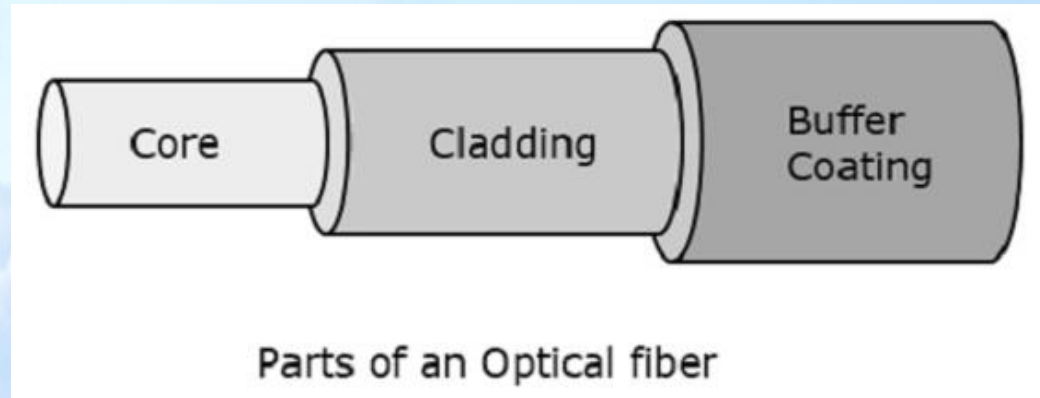

A solid di-electric material surrounds the core, which is called as **Cladding**. Cladding has a refractive index  $n_2$  which is less than  $n_1$ . Cladding reflects the light back into the core.

Cladding helps in –

- Reducing scattering losses.
- Adds mechanical strength to the fiber.
- Protects the core from absorbing unwanted surface contaminants.



# Optical Fibres- Principle

- ❖ Refractive Index of material : ratio of speed of light in vacuum to speed of light in medium
- ❖ Refraction of light : light refracts towards the Normal while entering a denser medium and **refracts away from Normal while entering a denser medium.** – (According to -Snells Law)

Snell's Law

$$\frac{n_1}{n_2} = \frac{\sin \theta_2}{\sin \theta_1}$$

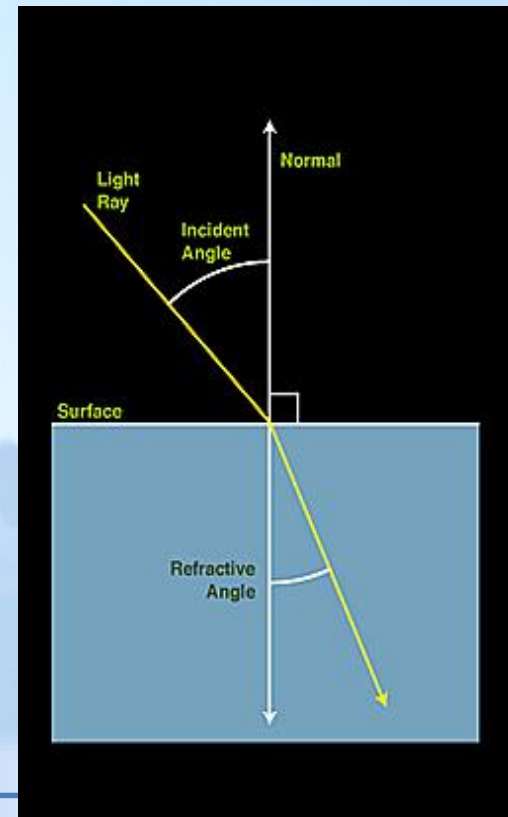
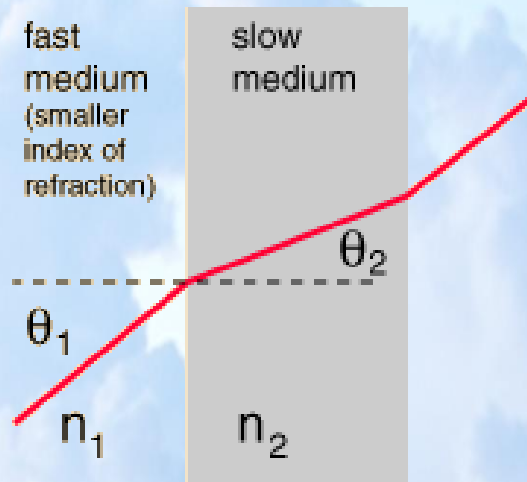

# Optical Fibres- Principle

- ❖ When Incident ray makes a Critical angle with Normal, the Bending is sufficient to keep the light ray along the boundary layer.
- ❖ If Angle of incidence is more than Critical angle then incident ray is reflected back into the medium. **This is called Total Internal reflection.** This property is used in Fibre Optic cables.

❖  $n_2 < n_1$

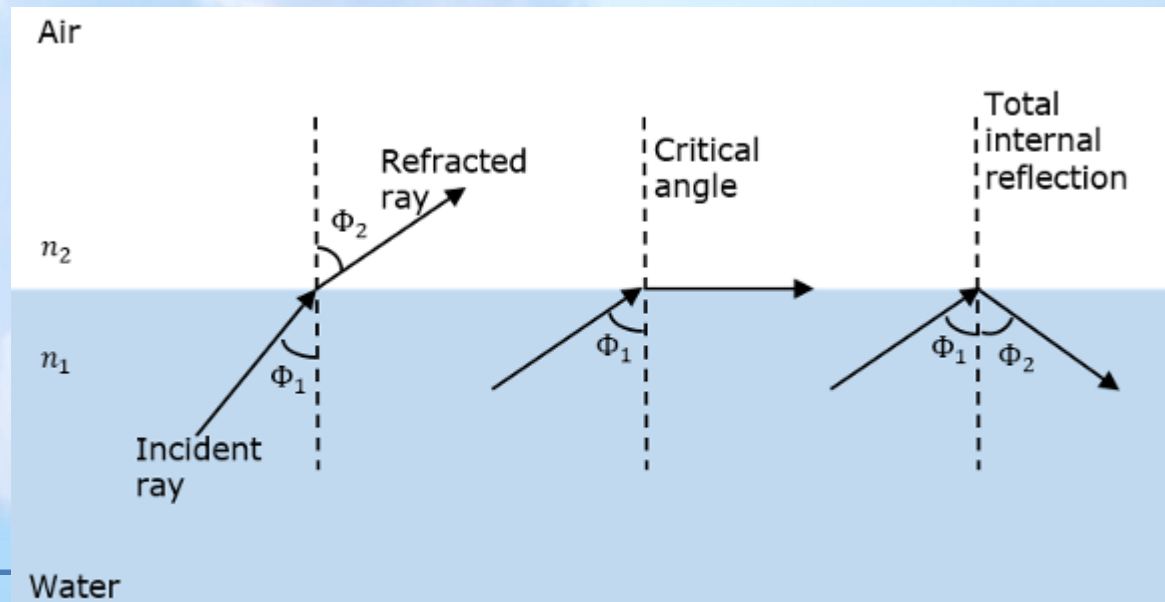

# Trapping Light in Fibre – Total Internal Reflection

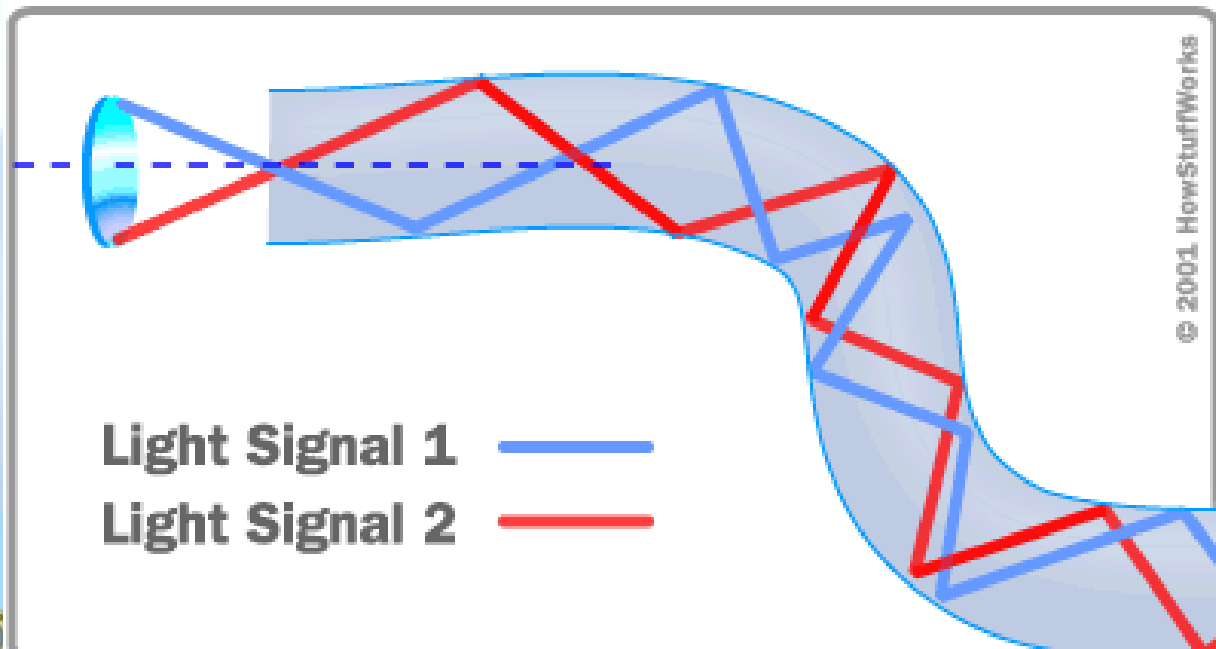
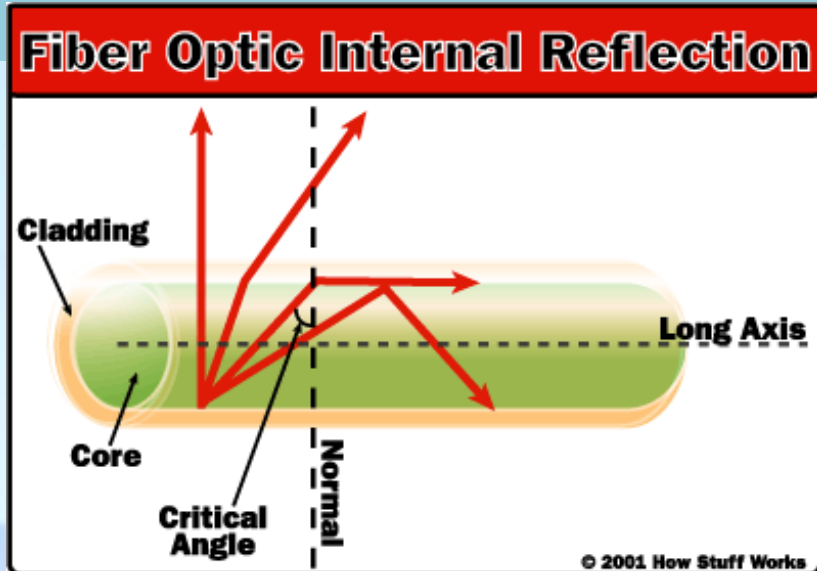

Light Signal 1 ————  
Light Signal 2 ————



# Types of Optical Fibres

Depending upon the material composition of the core, there are two types of fibres used commonly. They are –

- **Step-index fiber** – The refractive index of the core is uniform throughout and undergoes an abrupt change (or step) at the cladding boundary.
- **Graded-index fiber** – The core refractive index is made to vary as a function of the radial distance from the center of the fiber.
- **Single-mode fibers** have small cores (about  $3.5 \times 10^{-4}$  inches or 9 microns in diameter) and transmit infrared laser light (wavelength = 1,300 to 1,550 nanometers).
- **Multi-mode fibers** have larger cores (about  $2.5 \times 10^{-3}$  inches or 62.5 microns in diameter) and transmit infrared light (wavelength=850 to 1,300 nm) from light-emitting diodes (LEDs).



# Types of Optical Fibres

## ❖ Single mode -

- only one signal can be transmitted
- use of single frequency

## ❖ Multi mode -

- Several signals can be transmitted
- Several frequencies are used to modulate the signal



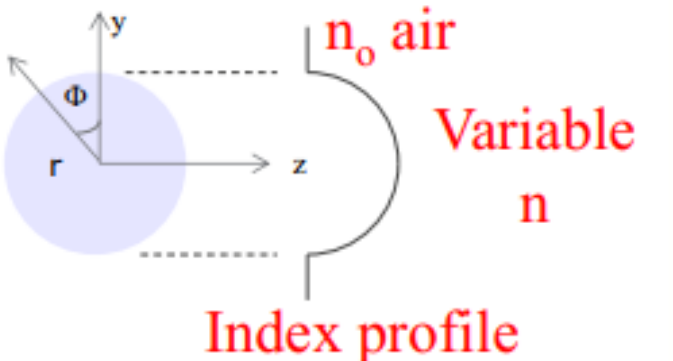
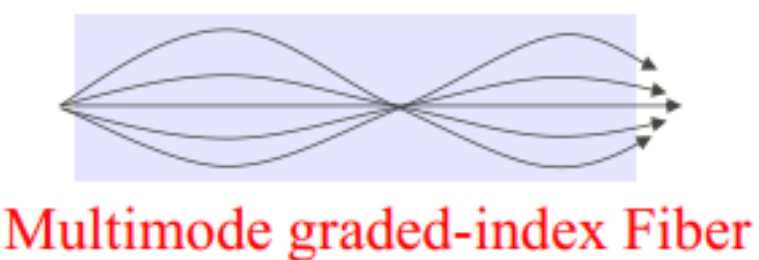
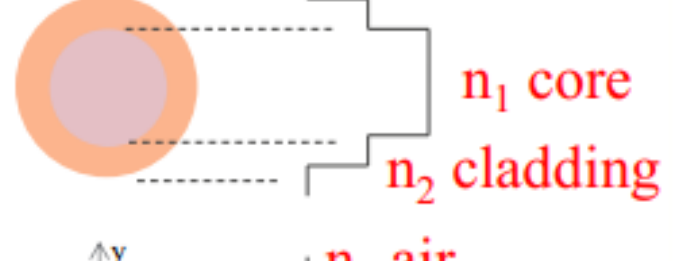
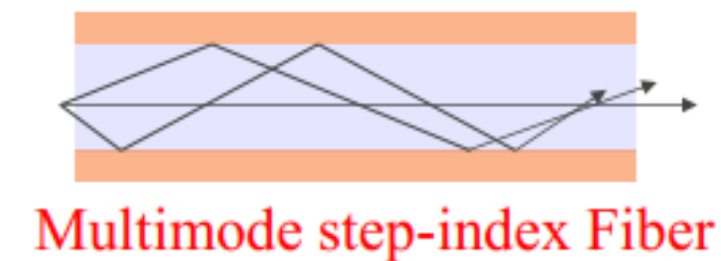
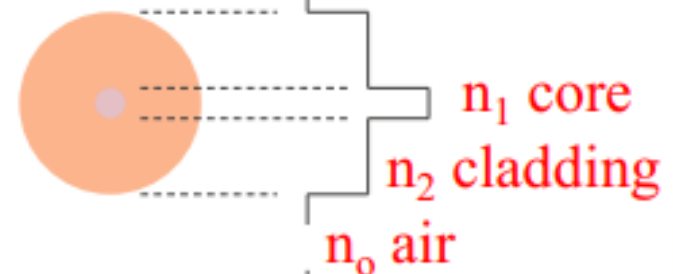

$$n_{\text{Core}} > n_{\text{cladding}}$$



# Video- Optical fibre communication explained (from Wikipedia)

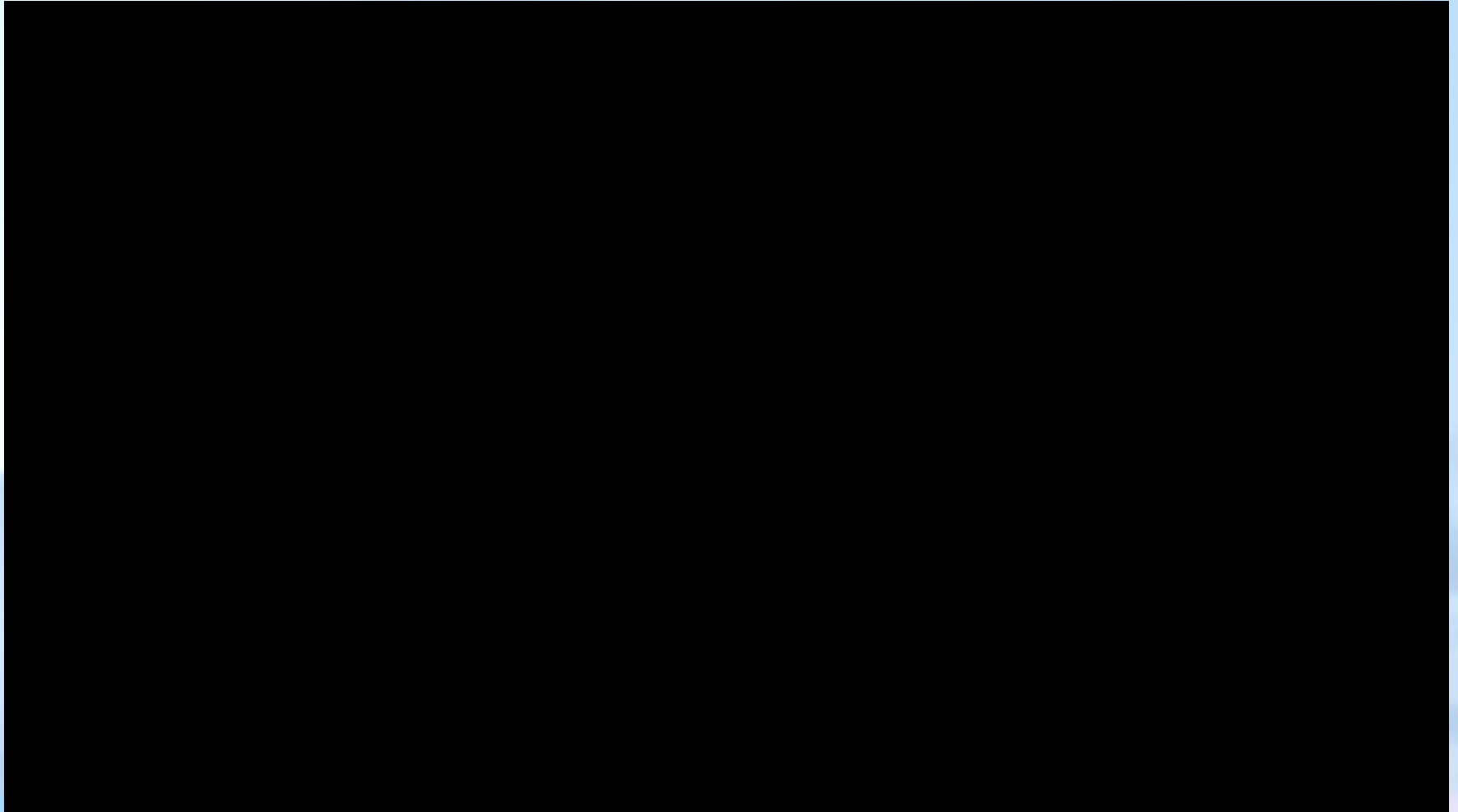



# Advantages of Fibre Optic Cable

- ❖ Less expensive than copper pair, Light in weight
- ❖ Non-flammable
- ❖ Can carry much more information
- ❖ Much higher data rates
- ❖ Much longer distances than co-axial cables (**very less attenuation** of signals in Optical fibre cables)
- ❖ Immune to electromagnetic noise
- ❖ Unaffected by atmospheric agents and immune to Electro magnetic Inference
- ❖ Very less chances of cross talk between nearby cables



# Disadvantages of Fibre Optic Cable

- Though fiber optic cables last longer, the installation cost is high.
- Optical fibre cables can carry only data whereas Copper UTP (Unshielded Twisted Pair) cables can carry data as well as power so IP Phones, Wireless Access Points etc can be powered by UTP cables / POE(Power Over Ethernet) switches.
- Cost of **Network equipments** is high. The number of repeaters are to be increased with distance.
- They are fragile if not enclosed in a plastic sheath. Hence, more protection is needed than copper ones.



# Losses in optical fiber:

## 1. Absorption loss: due to impurities in fibre composition

❖ Absorption loss is related to the material composition and fabrication process of fiber. Absorption loss results in dissipation of some optical power as heat in the fiber cable. Although glass fibers are extremely pure, some impurities still remain as residue after purification. The amount of absorption by these impurities depends on their concentration and light wavelength.

2. Radiative losses: also called bending losses, occur when the fibre is curved. There are two types of radiative losses: Micro bending losses. Macro bending losses.

3. Scattering loss: are caused by the interaction of light with density fluctuations within a fiber. Density changes are produced when optical fibers are manufactured.

4. Dispersion loss: Dispersion is a measure of the temporal spreading that occurs when a light pulse propagates through an optical fiber. Dispersion is sometimes referred to as delay distortion in the sense that the propagation time delay causes the pulse to broaden.



# Applications of Fibre Optic cables

- ❖ **Internet** is possible using long distance Fibre optic cables laid in oceans (**Submarine cables**)
- ❖ Used in telephone systems for providing FTTH connections
  - Used in CCTV surveillance cameras
  - Used for connecting fire, police, and other emergency services.
  - Used in hospitals, schools, and traffic management systems e.g. **NKN (National Knowledge Network)**.



# References and additional reading-

- ❖ [Lecture notes uploaded on METNET portal](#)
- ❖ [https://en.wikipedia.org/wiki/Optical\\_fiber](https://en.wikipedia.org/wiki/Optical_fiber)
- ❖ [https://www.tutorialspoint.com/principles\\_of\\_communication/principles\\_of\\_optical\\_fiber\\_communications.htm](https://www.tutorialspoint.com/principles_of_communication/principles_of_optical_fiber_communications.htm)



# Mobile Communication System

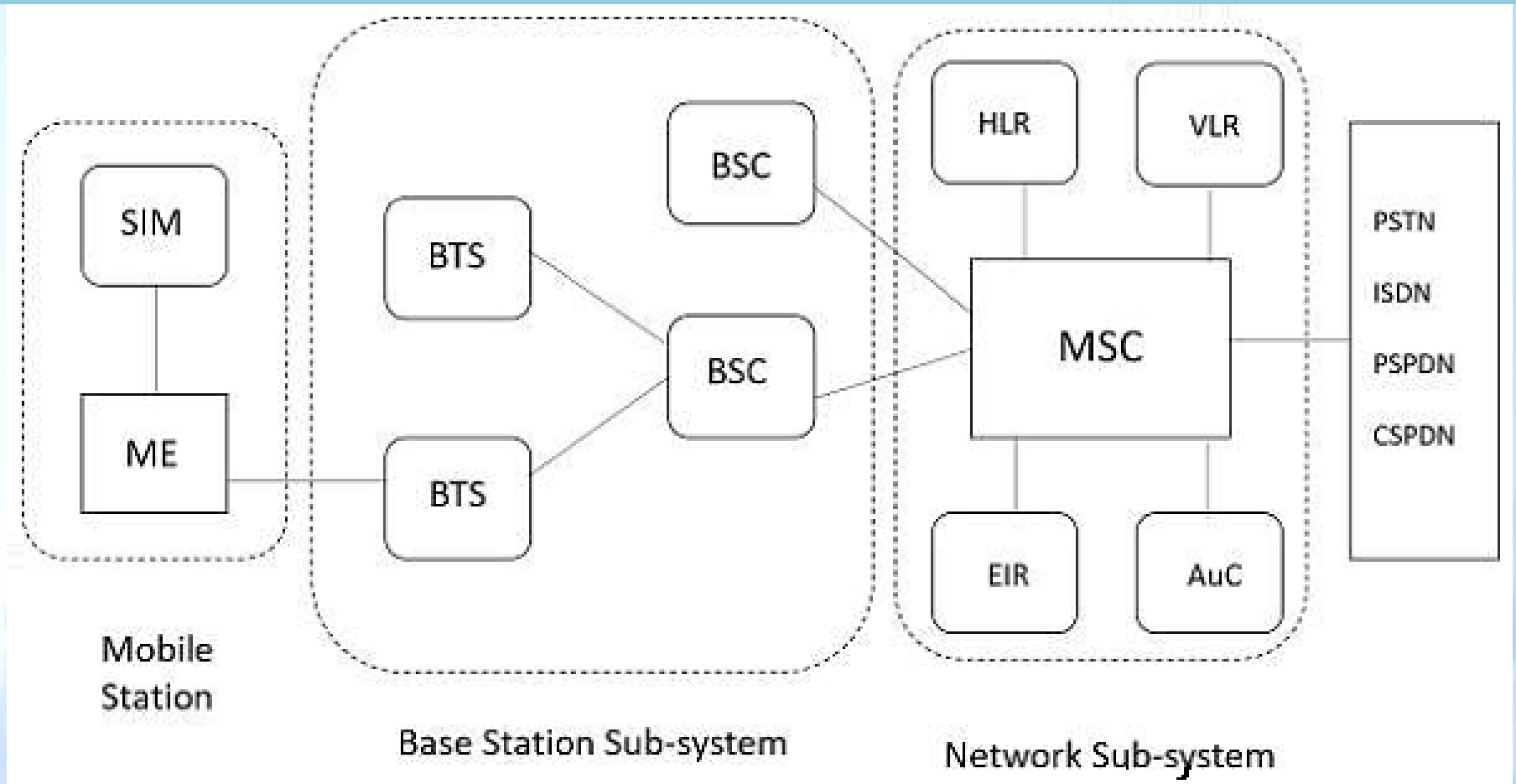

# How Mobile Telephony Works ?

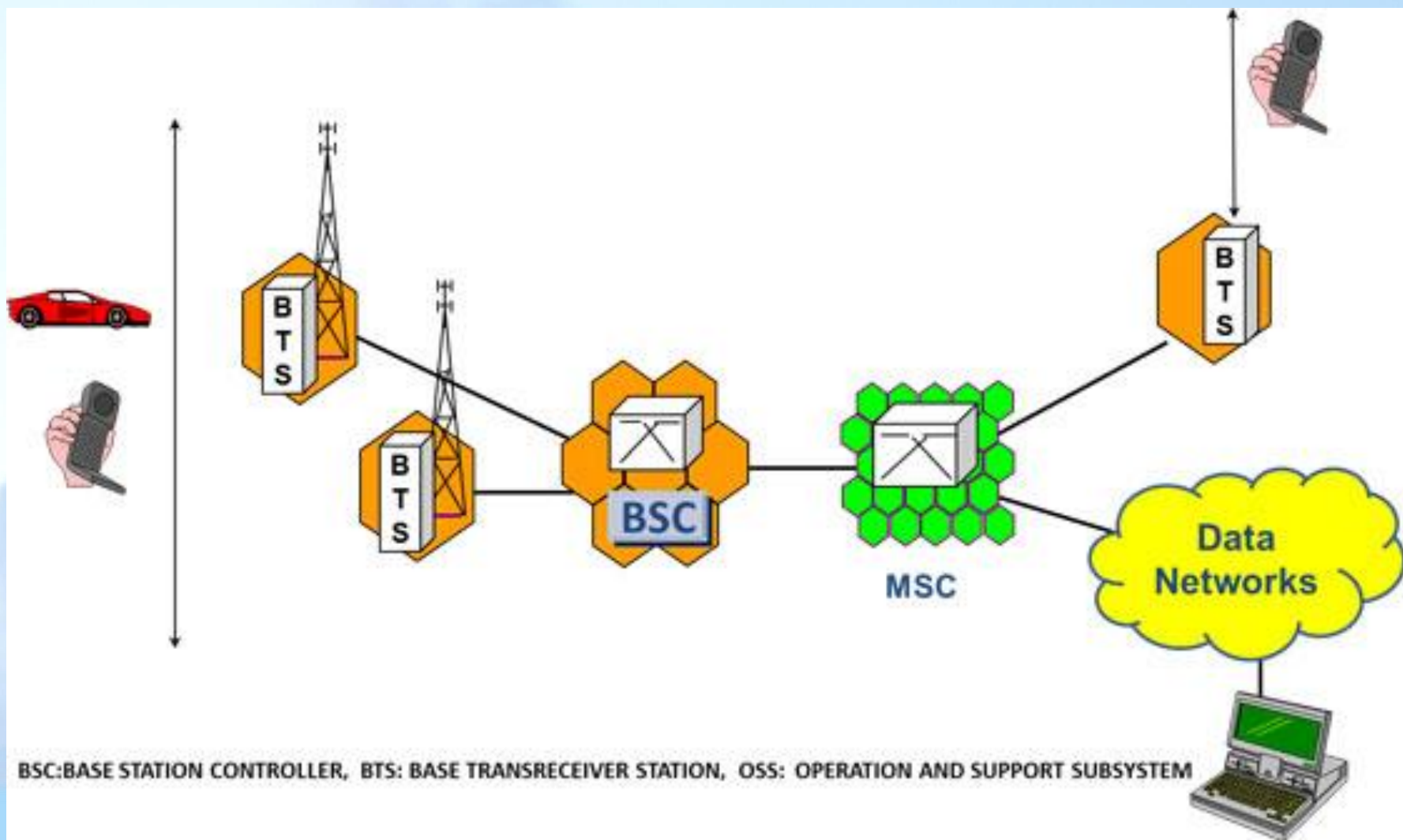



**Mobile Equipment (ME)** – ME is a piece of hardware that the customer purchases from the equipment manufacturer. The hardware piece contains all the components needed for the implementation of the protocols to interface with the user and the air-interface to the base stations.

**Subscriber Identity Module (SIM)** – This is a smart card issued at the subscription to identify the specifications of a user such as address and type of service. The calls in the GSM are directed to the SIM rather than the terminal.

SMS are also stored in the SIM card. It carries every user's personal information which enables a number of useful applications.

**Mobile Station (MS)** – The Mobile Station (MS) communicates the information with the user and modifies it to the transmission protocols of the air interface to communicate with the BSS. The user information communicates with the MS through a microphone and speaker for the speech, keyboard and display for short messaging and the cable connection for other data terminals. The mobile station has two elements Mobile Equipment (ME) and Subscriber Identity Module (SIM).

**Base Transceiver Station (BTS)** – The user data transmission takes place between the mobile phone and the base station (BS) through the base transceiver station. A transceiver is a circuit which transmits and receives, i.e., does both.

**Base Station (BS)** – A base station transmits and receives user data. When a mobile is only responsible for its user's data transmission and reception, a base station is capable to handle the calls of several subscribers simultaneously.





**Mobile Switching Center (MSC)** – MSC is the hardware part of the wireless switch that can communicate with PSTN switches using the Signaling System 7 (SS7) protocol as well as other MSCs in the coverage area of a service provider. The MSC also provides for communication with other wired and wireless networks as well as support for registration and maintenance of the connection with the mobile stations.

**Channels** – It is a range of frequency allotted to particular service or systems.

**Control Channel** – Radio channel used for transmission of call setup, call request, call initiation and other beacon or control purposes.

**Forward Control Channel(FCC)** – Radio channel used for transmission of information from the base station to the mobile

**Reverse Channel(RC)** – Radio channel used for transmission of information from the mobile to base station.

**Voice Channel(VC)** – Radio channel used for voice or data transmission.

**Handoff** – It is defined as the transferring a call from the channel or base station to another base station.

**Roamer** – A mobile station which operates in a service area other than that from which service has been subscribed

**Transceiver** – A device capable of simultaneously transmitting and receiving radio signals.



# Antennas Used

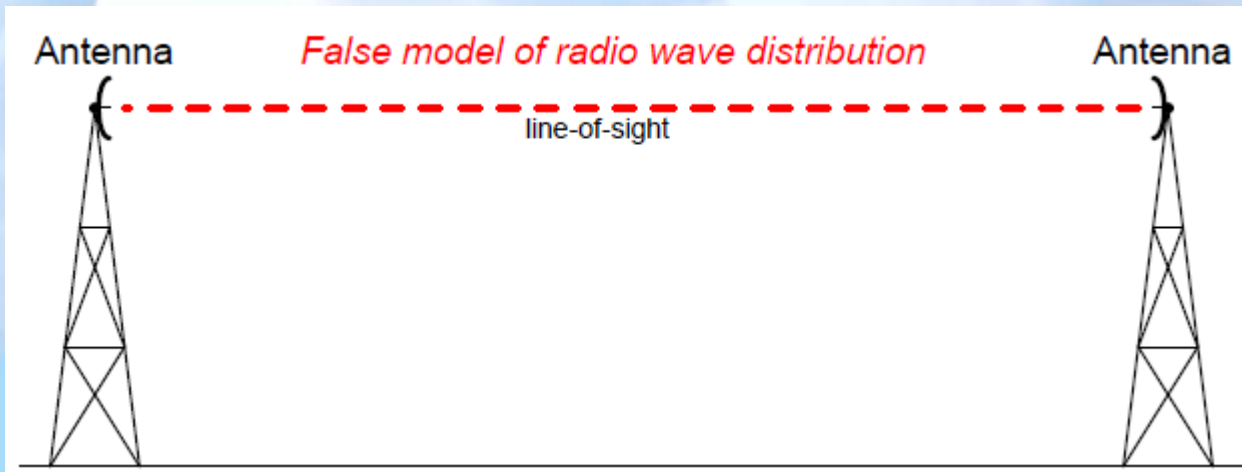

# How a cellular telephone call is made?

- Turn on a cellular phone
- The cellular phone scan the control channels to determine the one with the strongest signal, it then monitors the signal drops below a usable level. At his point, it starts to search of strongest base station again.
- If a phone call is placed to a mobile user, the MSC dispatches the request to all the base stations in the system, the MIN (mobile identification number, i.e. the mobile's phone number) is broadcast as a paging message through the forward control channel.
- The mobile receives the signal through the base station it monitors and responds by identifying itself through the reverse control channel.
- The base station informs the MSC of the handshake.
- The MSC instructs the base station to move the call to an unused voice channel within the cell.
- The base station signals the mobile to change frequencies to the unused forward and reverse voice channel pair.
- The base station instructs the mobile phone to ring, thereby to instruct the user to answer the phone.



# Cell Phone Technologies

## 4 Cell Phone Generations Compared

	Standards	Technology	SMS	Voice Switching	Data Switching	Data Rates
1G	AMPS, TACS	Analog	No	Circuit	Circuit	N/A
2G	GSM, CDMA, EDGE, GPRS	Digital	Yes	Circuit	Circuit	236.8 kbps
3G	UTMS, CDMA2000, HSPDA, EVDO	Digital	Yes	Circuit	Packet	384 kbps
4G	LTE Advanced, IEEE 802.16 (WiMax)	Digital	Yes	Packet	Packet	up to 1 Gbps



# 1G Technology

1G refers to the first generation of wireless mobile communication where analog signals were used to transmit data. It was introduced in the US in early 1980s and designed exclusively for voice communication. Some characteristics of 1G communication are –

- Speeds up to 2.4 kbps
- Poor voice quality
- Large phones with limited battery life
- No data security



# 2G Technology

- ❖ 2G refers to the second generation of mobile telephony which used digital signals for the first time. It was launched in Finland in 1991 and used GSM technology. Some prominent characteristics of 2G communication are –
  - Data speeds up to 64 kbps
  - Text and multimedia messaging possible
  - Better quality than 1G
- ❖ When GPRS technology was introduced, it enabled web browsing, e-mail services and fast upload/download speeds. 2G with GPRS is also referred as 2.5G, a step short of next mobile generation.



# 3G Technology

- ❖ Third generation (3G) of mobile telephony began with the start of the new millennium and offered major advancement over previous generations. Some of the characteristics of this generation are –
  - Data speeds of 144 kbps to 2 Mbps
  - High speed web browsing
  - Running web based applications like video conferencing, multimedia e-mails, etc.
  - Fast and easy transfer of audio and video files
  - 3D gaming
- ❖ Every coin has two sides. Here are some downsides of 3G technology –
  - Expensive mobile phones
  - High infrastructure costs like licensing fees and mobile towers
  - Trained personnel required for infrastructure set up
- ❖ The intermediate generation, 3.5G grouped together dissimilar mobile telephony and data technologies and paved way for the next generation of mobile communication.



# 4G Technology

❖ Keeping up the trend of a new mobile generation every decade, fourth generation (4G) of mobile communication was introduced in 2011. Its major characteristics are –

- Speeds of 100 Mbps to 1 Gbps
- Mobile web access
- High definition mobile TV
- Cloud computing
- IP telephony

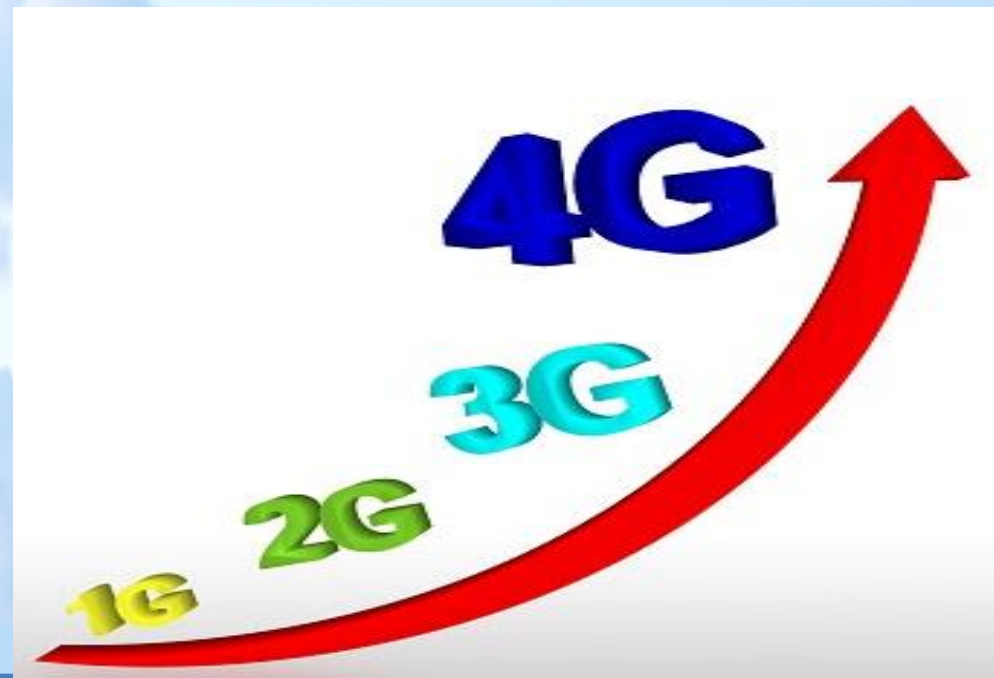



Thanks  
for your support

